

Scanning Tunnelling Microscopy measurements of Carbon Nanotubes

- Experimental work for “Molecular Nanotechnology” Summer School

Maria Nordström and Susan Nyrup

August 2004

Work performed at the Physics Institute at the Technical University of Denmark with help of Jakob Svagin.

Aim: The aim of the work carried out is to investigate the possibilities of observing multi-walled carbon nanotubes (MWCNT) with the scanning tunnelling microscope (STM) recently bought by the Physics Institute.

The work started with observing graphite and gold surfaces and after becoming familiar with the equipment and knowing the structures of these, we started the hunt for carbon nanotubes. The samples we studied had previously been examined with an atomic force microscope (AFM) to confirm the presence of the tubes.

We managed to find and image nanotubes, but it proved to be very difficult. The main reason for that is probably the instability of the equipment.

Introduction: Scanning tunnelling microscope (STM) was invented in 1981 and offers a method of investigating the electron density of conducting materials. By scanning a tip over a surface with an applied voltage across the two, an image can be built up of the tunnelling current across the gap. Special software is used for controlling the tip and it can be set to either keep a constant current or a constant distance between the tip and the surface as it scans. The first method results in data over changes in the electron density as the tip is forced to move away from the surface if it encounters electron dense areas to ensure a constant current. The second method gives information in changes in the tunnelling current as the tip never moves but keeps a constant separation between the tip and surface, usually about 1 nm. In our work, we only used the first method, where a constant tunnelling current of 1 nA was used.

The STM we used was an EasyScan STM from NanoSurf, Switzerland, figure 1. The Physics Institute has invested in five such set-ups for student use. The systems have a diameter of 1 dm and are kept standing on the table on a “vibration isolation platform” with only a Plexiglas cover on top. The tip used is a PtIr wire cut into suitable lengths by hand. The sharpness of the tip is of highest importance and a new tip had to be prepared several times. The maximum scan range of the STM is 500x500 nm² and there are no possibilities of moving the sample other than by hand. Obviously this limits the accuracy of the scan areas.

We wanted to investigate multi-walled carbon nanotubes (MWCNT's) on graphite surfaces. Carbon nanotubes have been observed by STM many times before but there, much more advanced systems have been used. The challenge here was to image carbon nanotubes under ambient conditions with a student STM set-up.

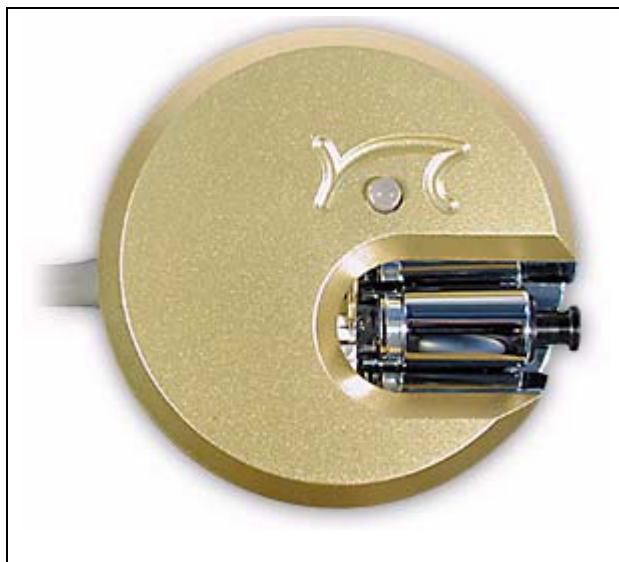

Figure 1a. Image of the set-up used seen from above. The diameter is ~ 1 dm. The metallic cylinder on the right is the sample holder and the tip is placed facing head-on.

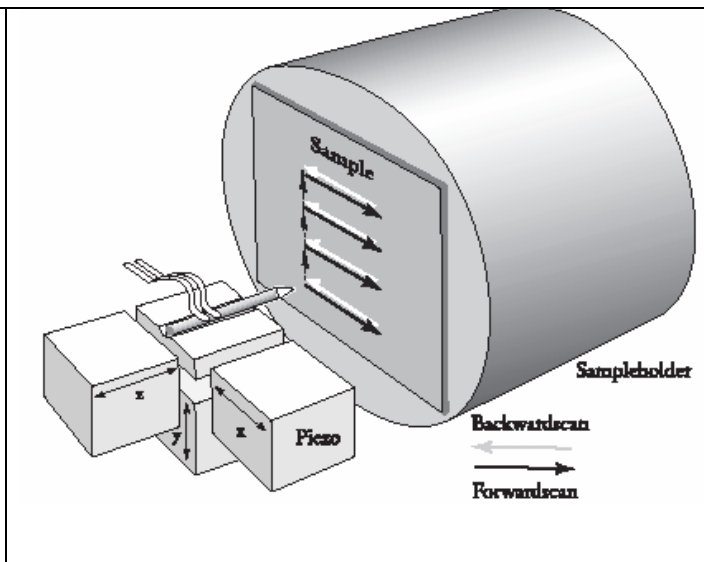

Figure 1b. Schematic drawing of the positioning of the tip relative to the sample.

Experimental Procedures:

E-STM: We started the work by just imaging graphite surfaces (HOPG) and Au surfaces to get familiar with the equipment and learn how to interpret the STM images. For the HOPG surface, atomic resolution could be obtained, figure 2a. For the Au surface grain boundaries could be observed, even though the quality of the pictures is not too good, figure 2b.

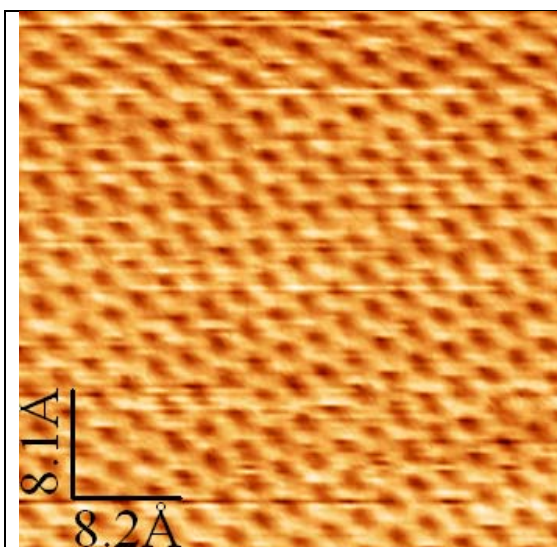

Figure 2a. The atomic resolution of the graphite surface can be seen.

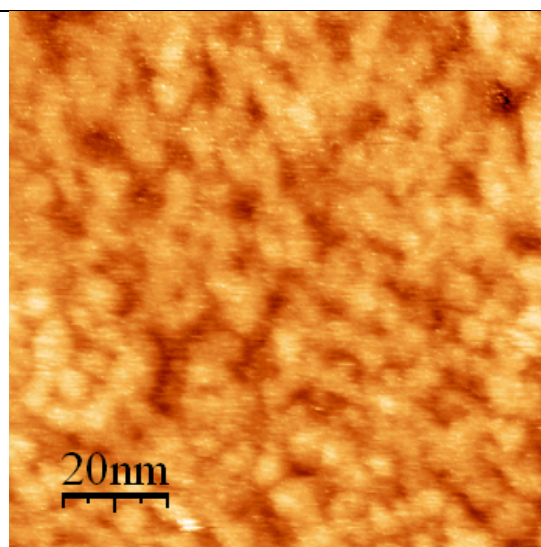
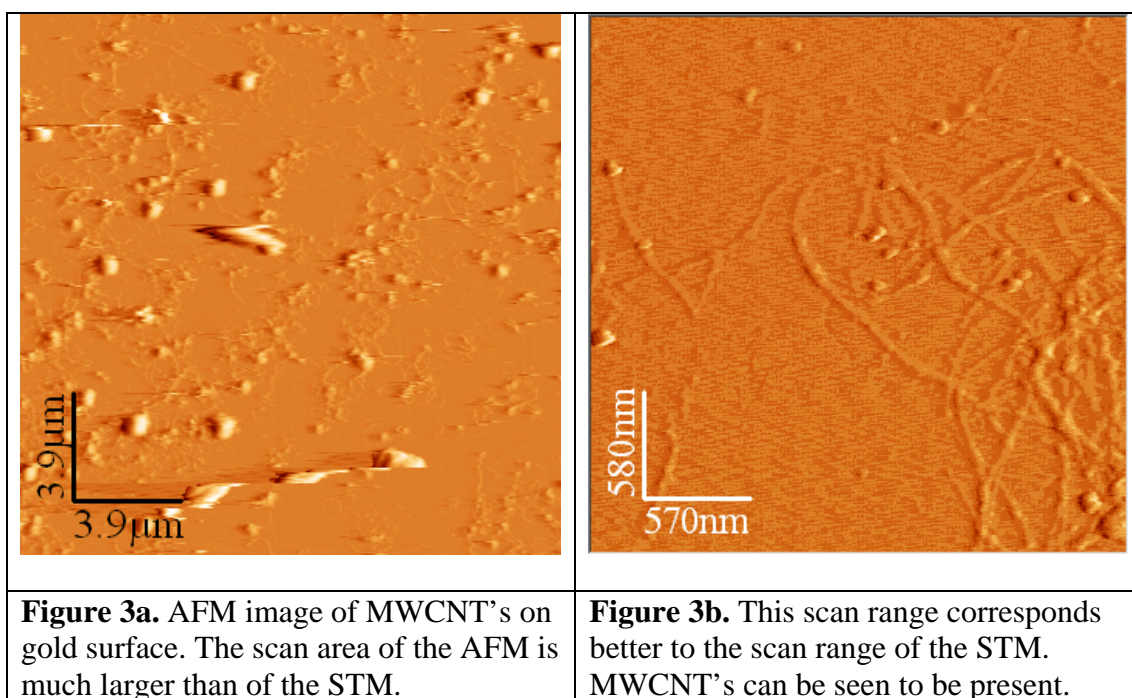

Figure 2b. Grains making up the gold surface can be hinted.

Carbon Nanotube Samples: The samples with carbon nanotubes were prepared by dissolving the tubes from powder form in chloroform under ultra sonic stirring. The nanotubes had a diameter of 15 nm and length of a few microns. Droplets of the solution were then dispersed onto the HOPG surface and the solvent was allowed to evaporate. The samples were first imaged with AFM using contact mode, to ensure their presence, figure 3.



From the figures above, one can see that there are MWCNT's present on the surface. They seem to be clustered together into larger bundles rather than lying one by one. The AFM image in figure 3a corresponds to 1600 STM images, as the scan range of the STM is much smaller than of the AFM. This also shines light onto one of the major difficulties with the experiment – to find the nanotubes! These images are taken of MWCNT's on a gold surface whilst the nanotubes we studied were deposited onto HOPG. The AFM is only capable of scanning in contact mode and the nanotubes appeared to adhere much stronger to a gold surface.

STM of Carbon Nanotubes: As mentioned before, one of the major difficulties with this experiment was to initially find the nanotubes on the surface. We started by making 500x500 nm² scans until something that looked like a nanotube appeared. Most of the times, nothing but the characteristic planes of the graphite surface was seen, figure 4.

However, on a few occasions we managed to image MWCNT's, figure 5. On this magnification, it is very difficult to see whether the image shows only one or more nanotubes closely together. However, the width does not compare well with the expected value (diameter of 15 nm), which leads us to believe that it was not a single tube. On the other hand, there will always be a “broadening effect” of the STM scans due to the topography of the tip. An attempt was made to zoom in on the nanotubes to be able to investigate the structure in more detail, figure 6. There appears to be some underlying structure on the tube that follows along the length of the tube. This could be showing that there are actually a bundle of a few nanotubes together. However,

success upon zooming further in was never achieved as the nanotubes disappeared out of the scan window after the second scan.

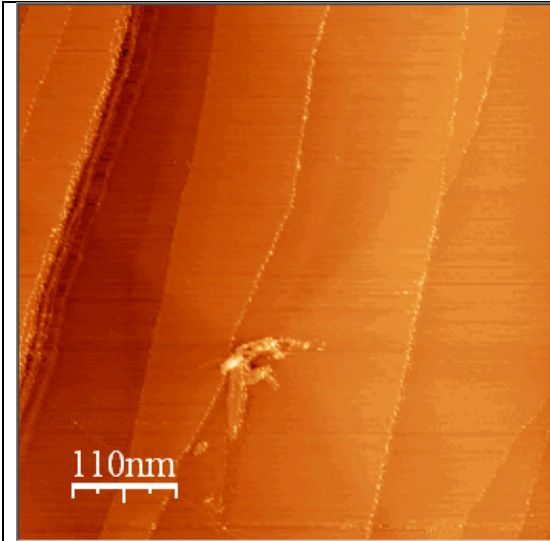

Figure 4a. A typical STM image of the planes between the graphite layers. In the centre of the image some dirt is seen.

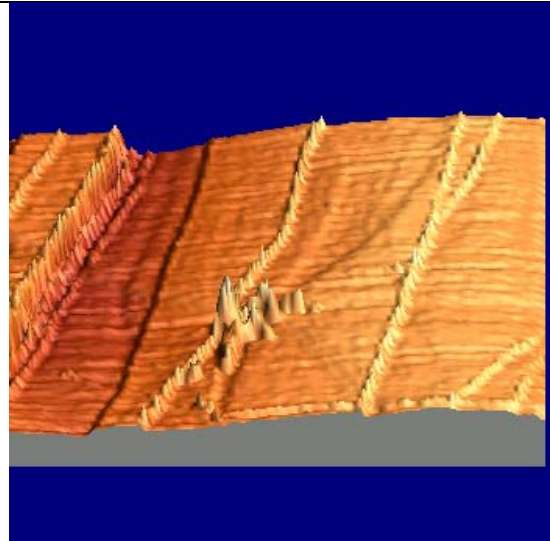

Figure 4b. STM image from figure 4a shown in 3D. The steps between the planes are easily seen.

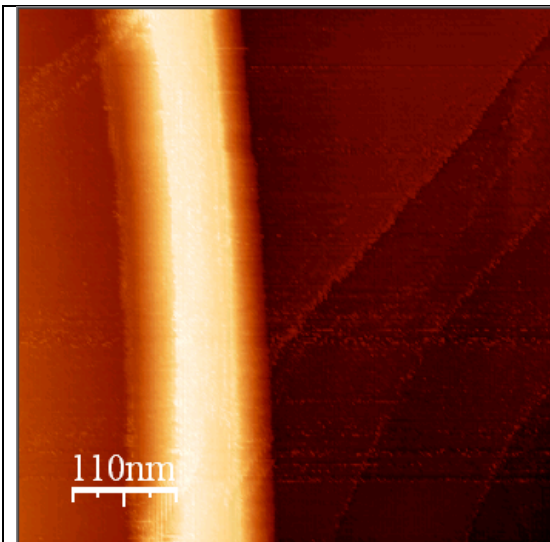

Figure 5a. STM image of a MWCNT. Height of the tube is 1.5 nm and the width is 120 nm.

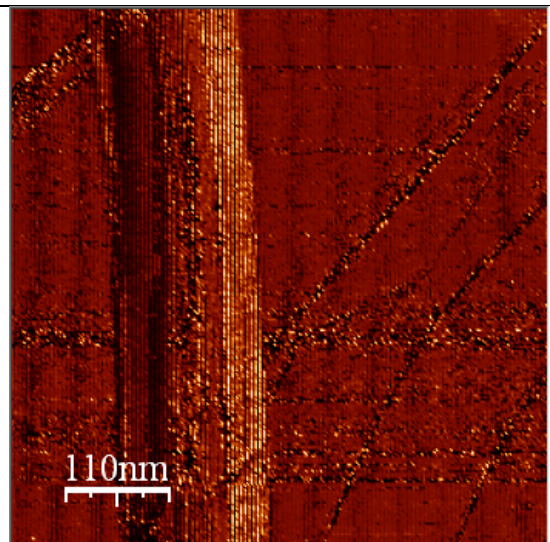
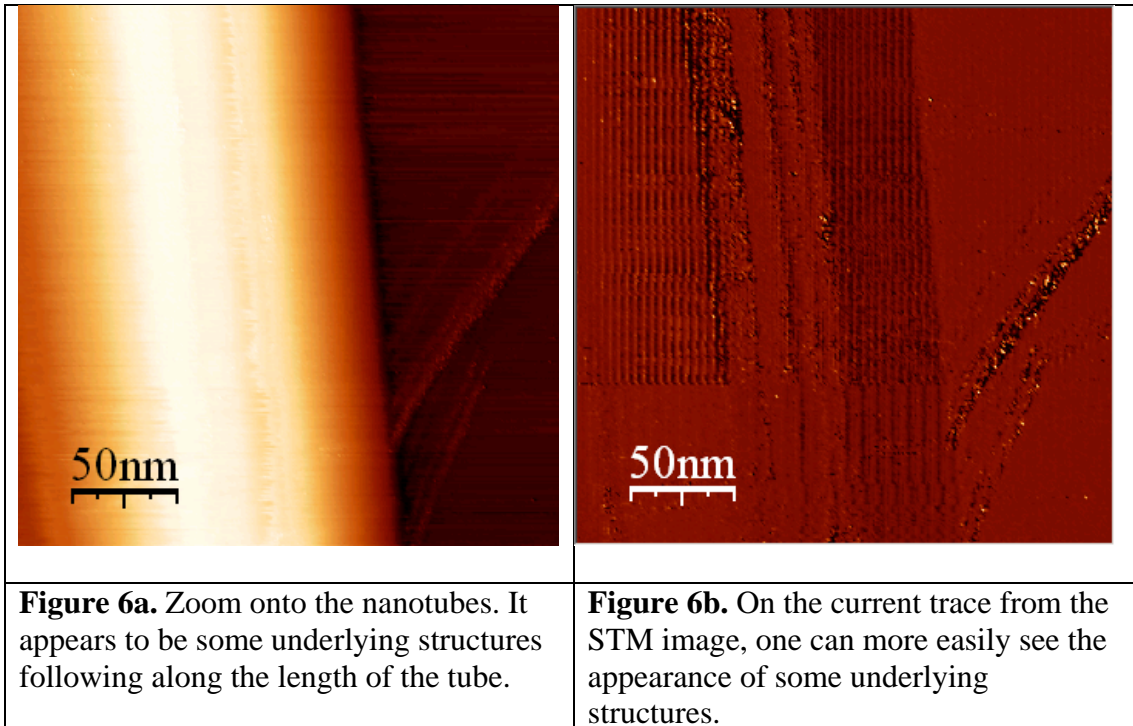

Figure 5b. Current trace of figure 5a.



This was another difficulty often encountered; the fact that the tubes seemed to “migrate” over the surface. It is not fully clear whether the tubes were affected by the STM tip and actually moved on the surface, or whether it was due to drift of the equipment. Repeated scans were performed over an area where no tubes were found and it was possible to reproduce this image several times without a significant drift. However, as soon as some tubes were scanned, difficulty with major drift was encountered. This effect cannot be explained fully but it could be that the presence of a nanotube affects the set-up so strongly that the drift suddenly increases drastically. It could be due to the movement of the piezo-elements or the increase in current drawn through the system that generates heat, which increases the drift. Below, some images are shown that support the theory that the nanotubes themselves are actually affected by the scanning tip, figure 8.

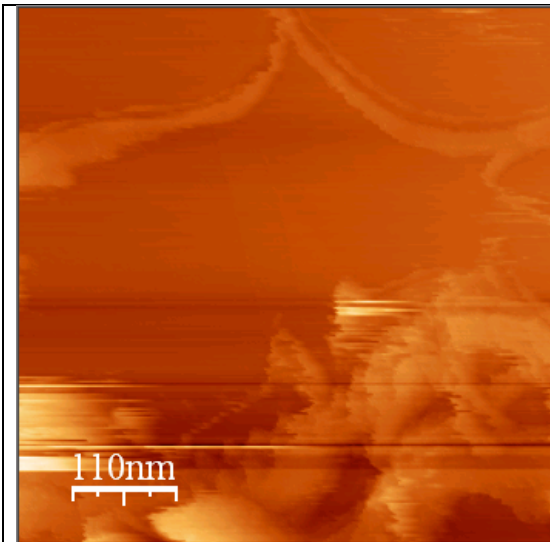

Figure 8a. Overview scan of an area with a large nanotube bundle at the bottom and a few strains at the top.

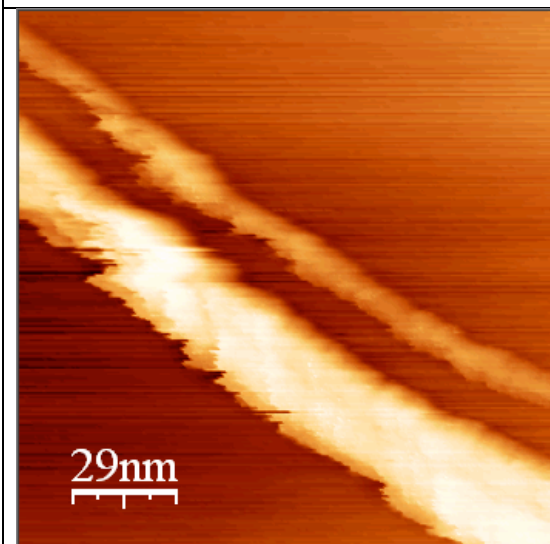

Figure 8b. Zoom at the top right of the image

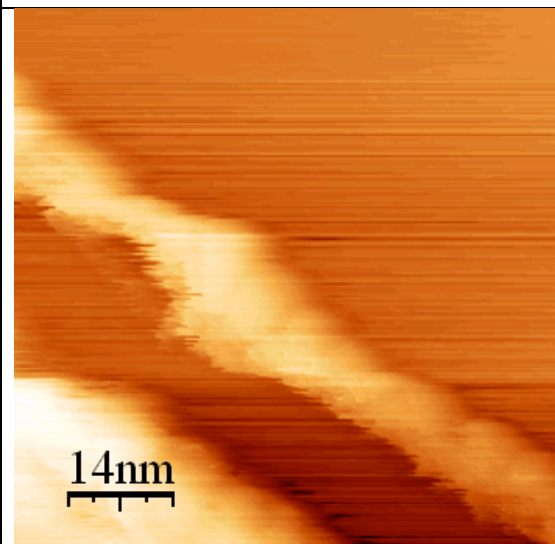

Figure 8c. Further zoom at the same area.

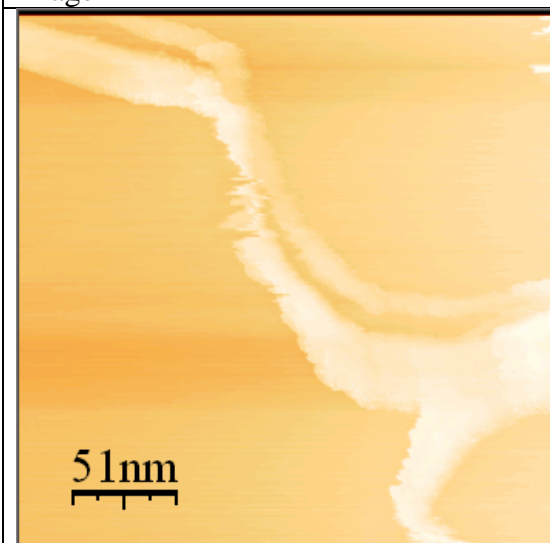

Figure 8d. Upon zooming out, it appears the previous zooms have affected the nanotube and a small "crack/bend" can be seen. However, we were never completely sure if it is actually the tube moving or whether it is just a phenomenon from the set-up such as drift.

Conclusion: We managed to obtain STM images of MWCNT's on HOPG surfaces, which was the aim for this experiment. Even though the system we used was not shielded from vibrations or temperature changes, nor did it have vacuum, we still managed to obtain images of atomic resolution of the HOPG surface. We also managed to obtain clear STM images of MWCNT's. This has never been achieved on these set-ups before.

Obviously the rough standard of the set-up caused some difficulties such as; drift due to temperature changes and hard taps on the table. The tip of the STM was also easily crashed into the surface of the sample and had to be changed often.

The effect of the chloroform upon dilution of the tubes should be studied in more detail. It might be that some organic residues from the solvent are left on the tubes and this might act as an isolating layer of the tubes, thus explaining the difficulties of imaging them. This could also explain the high probability of crashing the tip whenever scans were performed at a region with nanotubes; if the tubes have an insulation layer over them the tip would move closer to the surface until it crashes. It would be interesting to see if the probability of crashing was equally high in the presence of nanotubes if "constant height" mode was used.

It would also be interesting to scan nanotubes prepared on gold surfaces, as the images from the AFM, figure 3, show a high density of the tubes even on the smaller scan area.

As neither of us have worked with STM before we found this experimental experience very fruitful.